

HANATEK

Crease and Board Stiffness Tester



CBT1

Model 9011

INSTRUCTION MANUAL

Rhopoint Instruments
Hanatek Instruments
Rhopoint House
Enviro 21 Park
Queensway Avenue South
St Leonards on Sea
TN38 9AG UK

Tel. No. +44 (0)1424 739623

Fax No. +44 (0)1424 730600

sales@hanatekinstruments.com

www.hanatekinstruments.com

Contents

	Page
Introduction	2 - 3
Instrument menus and screen	4 - 9
Identifying grain direction	10
Sample for board testing	11
Sample for crease testing	12 - 13
Board test	14 - 16
Crease test	17
Interpretation of results	18 – 19
Exporting results	20 - 21
Calibration	22
Maintenance	23

The Hanatek Crease and Board Stiffness Tester



1. Identifying parts on the crease and board stiffness tester

The crease and board stiffness tester measures the force required to hold a creased sample folded to 90° or a board sample bent through 15°, the results being taken after these conditions have been maintained for 15 seconds (s). The samples are bent against the load cell blade (F) and the force on this blade is displayed on the LCD display (C).

Operating the instrument is through rotating the relevant test jaw (J + I) and using the capacitive touch buttons (D)

The display automatically displays the force reading at the end of the 15s test period. Both results from crease testing and board stiffness testing are stored in separate columns with batch testing stats and the crease to board stiffness ratio also displayed.

To operate, the instrument needs connection to a 110-240V AC supply via the AC-DC 24V power adapter. The power DC power input socket and ON switch is located at the rear of the instrument (G).

At switch-on, the display (C) will display the instrument serial number, last certified date and the firmware version loaded into the three PCBs inside the CBT instrument. This information may be requested by Hanatek or approved repair centres if you require technical assistance at any stage.

It is recommended with any measuring equipment that it is left for thirty minutes to warm up before commencing testing. The recommended operating conditions as stated in the standard BS6965 is 23deg C at 50% r.h.

Instrument Menus and operating screens

The instrument has been designed for ease of operation with options shown in images and symbols where ever possible.

Start up screen

On first power up Initialising hardware please wait will be written on the screen below the firmware version numbers.

During this period do NOT touch the cap buttons as they are calibrating.

Wait until the screen display is as below and then touch any of the cap sense buttons to continue.

Cap buttons are highlighted with a red X

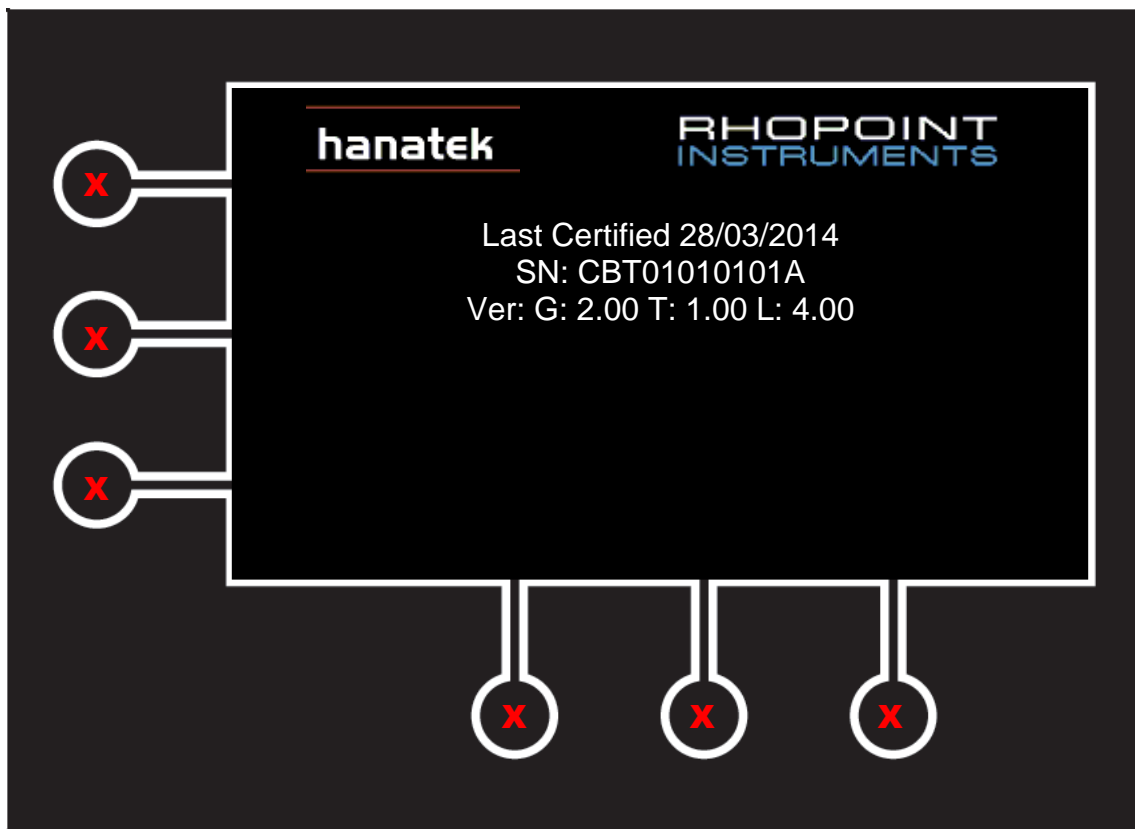

Main Operating Screen

The main operating screen is shown below. On the left-hand side are the following icons.



Enter Options Menu



Tare/Zero the instrument



Output test data

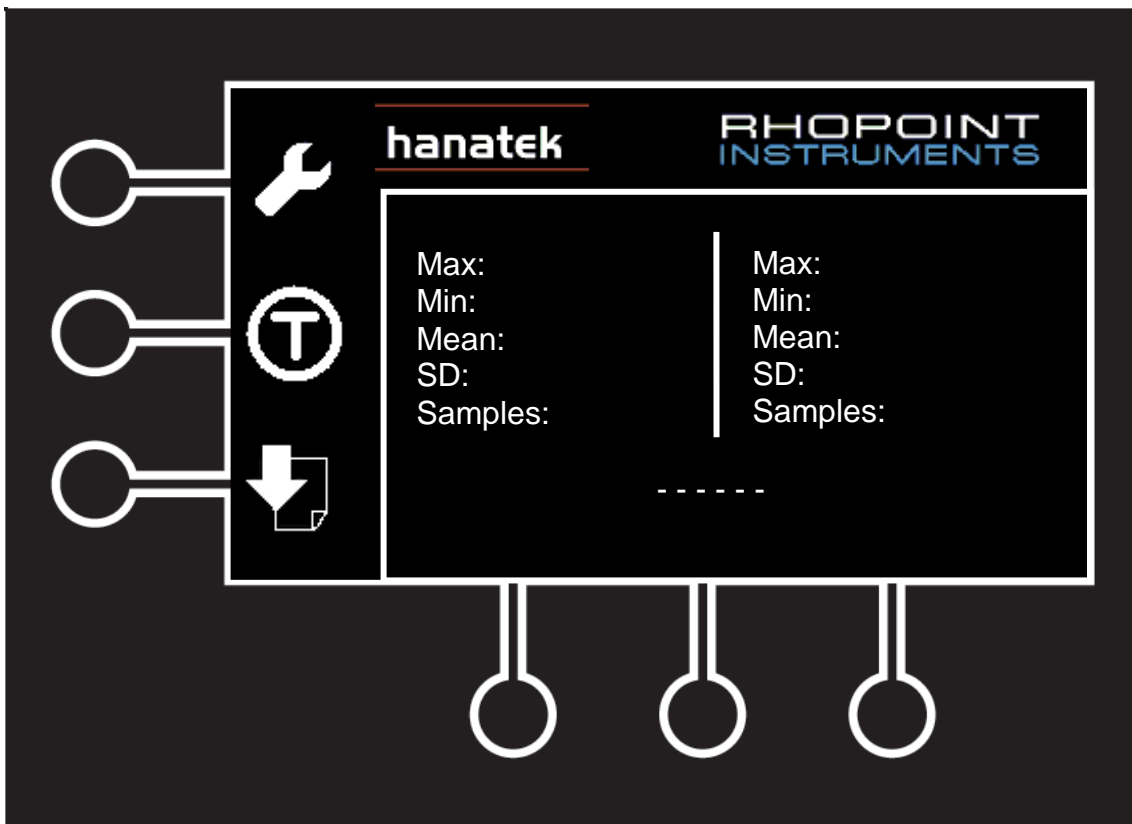

Options Screen

The options screen is shown below. On the left-hand side are the following icons.



Adjust time and date



Adjust test time from 10-15 Seconds *

15seconds is specified in the standard BS6965 and the recommended time.



Turn Stats display on and off

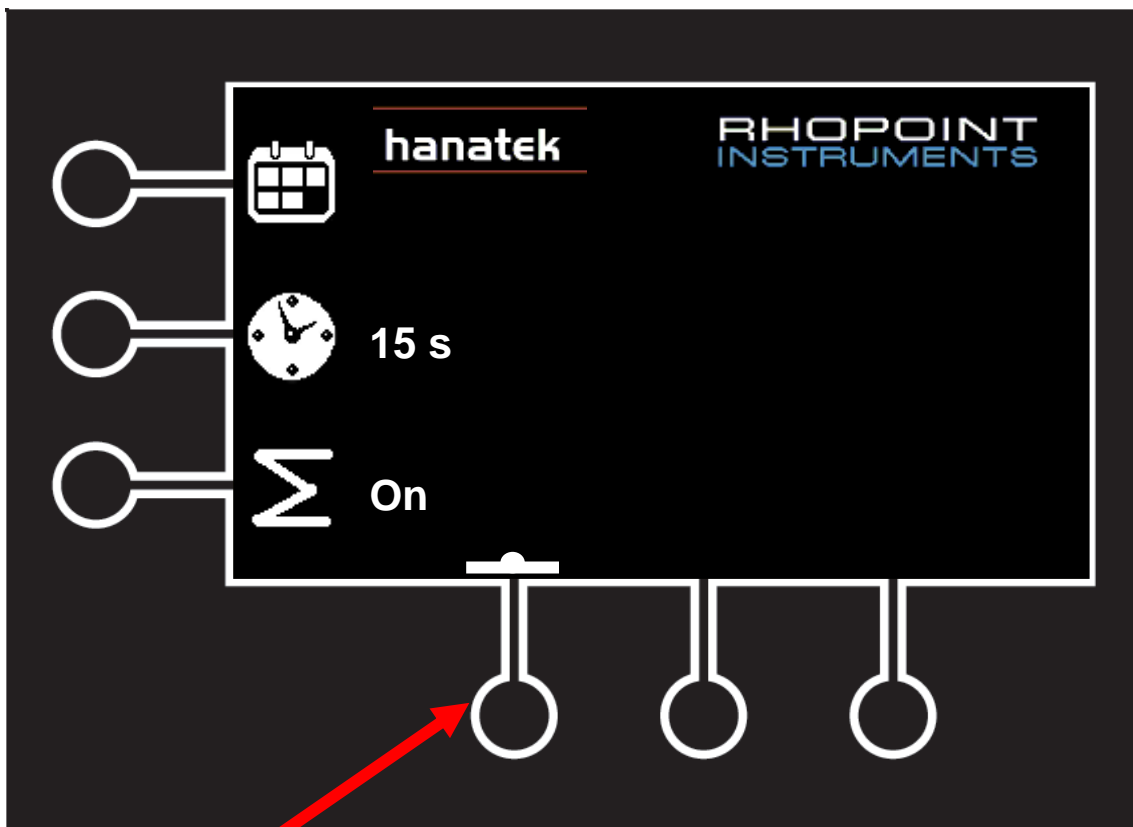

Return to main test screen

Adjusting the time and date

From the options screen press the button next to the  icon. Press the middle button on the bottom button bar to enable adjustments. Use the up and down arrows to adjust the green highlighted field. Pressing the middle button will skip to the next field. When finished press the left hand button to save and exit to the main screen

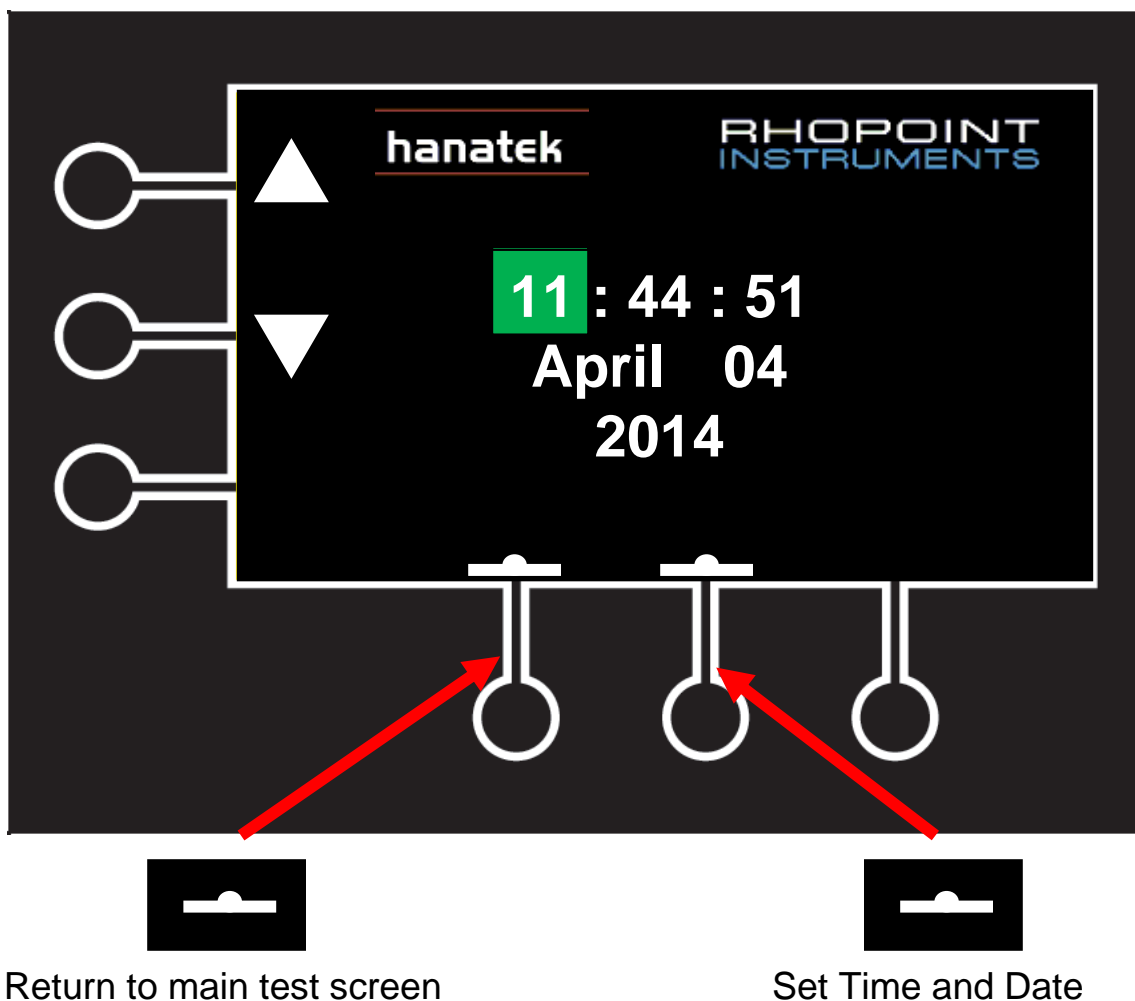

Adjusting the test time

From the options screen press the button next to the  icon. This will cycle the test time from 10-15 seconds. The Standard BS6965 recommends 15seconds. It is recommended that the operator does not deviate from this.

Turning Stats On and Off

From the options screen press the button next to the  icon. This will cycle from On - Off.

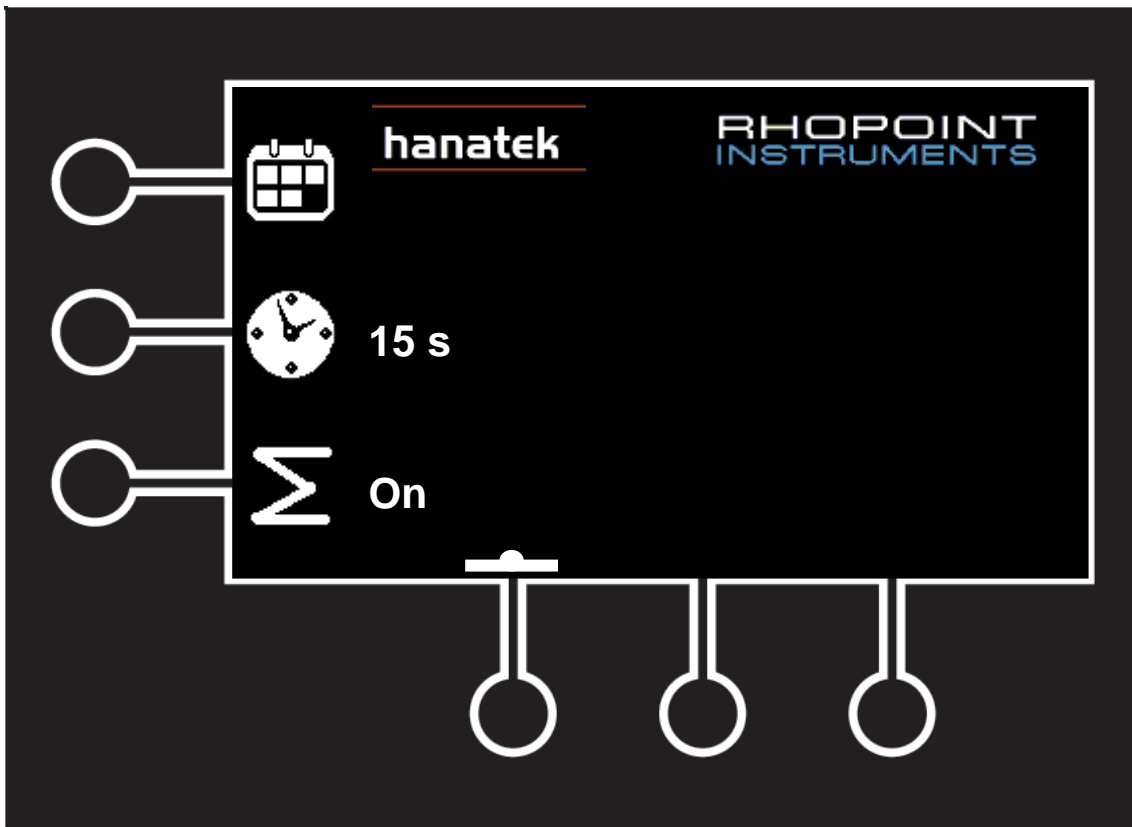

Return to main test screen

Using the Instrument

At the beginning of testing, and at regular intervals during extended testing, it is recommended that the instrument tare button is pressed to re-zero.

Before placing a sample in the clamp, Press the cap sense button next to the **T** icon on the screen (K).

The sample for testing may now be inserted in the appropriate clamp (J) for board stiffness, (I) for crease. To open the clamp, rotate the knob (H). Further details of setting up samples in the clamps are given later in the text. On turning the appropriate jaw to fold the sample the timing sequence is automatically initiated.

After 15 s the timer the stiffness result is displayed on the display. This figure is held until the next sequence.

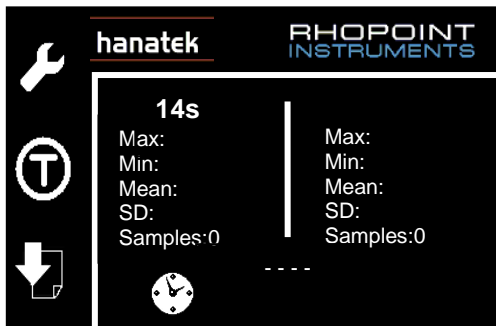

When the sample jaw is rotated the countdown timer will start and the clock will show at the bottom of the screen

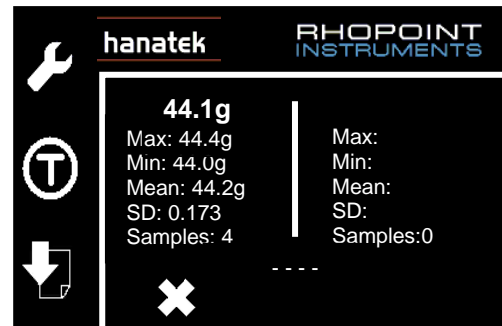

When the countdown timer has finished the X will show at the bottom of the screen indicating the jaw needs to be returned.

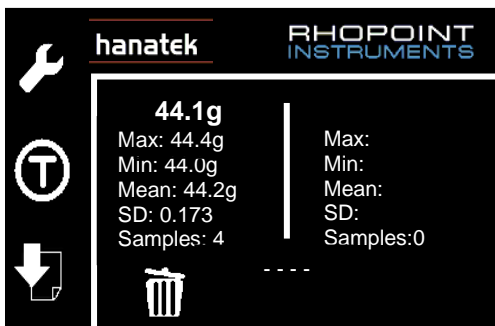

The bin icon is shown allowing the user to discard the last test result. Pressing and holding the button will delete all the samples.

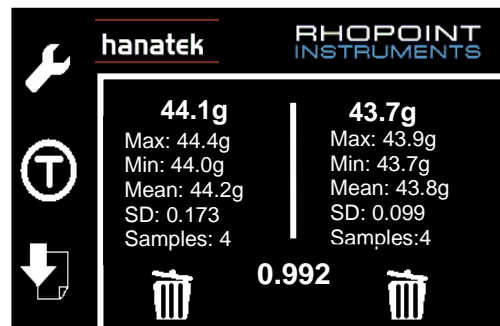

Main test screen showing 4 crease and 4 board tests. The ratio has been calculated automatically.

Note that the force on the load cell blade should NEVER exceed 550 grams (g).

Board is manufactured in a continuous strip, the direction in which it moves through the board-making machine being known as the machine direction (MD).

Board is always stiffer in the machine or grain direction than perpendicular to it. This second direction is called the cross, or across grain direction (CD).

The machine direction of board may be identified by flexing the board, preferably in the form of a square, holding first one pair of opposite sides, then the other. The board will feel stiffer when the machine direction runs from hand to hand.

The stiffness tester can be used to measure the force required to bend board in the machine and cross directions.

Cutting samples for board stiffness measurement

The required size of board sample for measuring board stiffness is 70mm x 38mm. The board direction required for test should run along the 70 mm length of the specimen. This is illustrated in diagram 1.

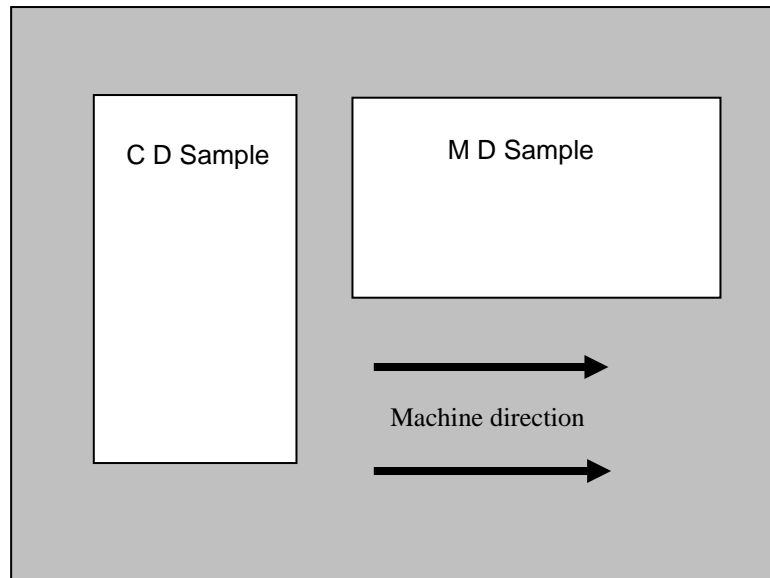

Diagram 1

These samples are easily prepared using the sample templates supplied or any of the optional Hanatek sample preparation cutters.

A number of samples should be tested in each direction. It is recommended that you test MD and CD separately to get accurate results and a crease to board stiffness ratio.

Ten samples per direction should give adequate accuracy, though some formal testing standards require a higher number.

To avoid confusion it is helpful to label the samples MD or CD after cutting.

Cutting samples for crease stiffness measurement

The supplied templates and optional sample cutters are used for cutting board stiffness samples and cutting the crease stiffness samples, in some cases extra operations are required.

The size of a standard BS6965 crease sample is 38x38 with the crease line 13mm in from one edge.

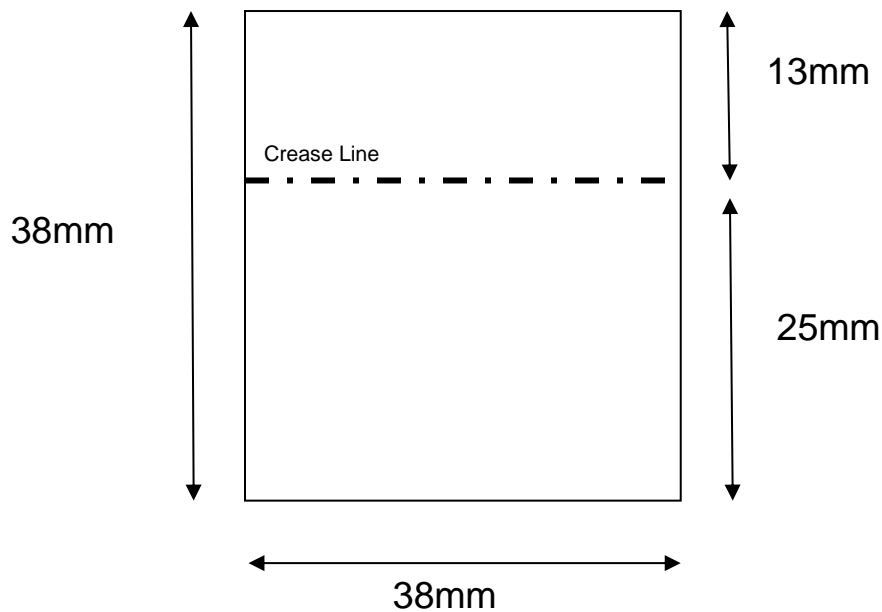

The CBT1 instrument is designed to test crease samples of the above size only.

If it is not possible to cut a standard size sample the Hanatek CFA instrument will allow the user to test non standard size samples.

Diagram 2 illustrates MD and CD samples with creases across them, as will be required for crease stiffness testing. Confusion can arise from the naming of the creases, as the crease in the MD sample runs across the grain indicated by the arrow. This crease is known as the MD crease, named after the MD sample it is taken from. Similarly, the crease in diagram 2B is known as the CD crease, it is taken from a sample cut in the CD direction. The reason for this is that the stiffness of the MD crease relates to the stiffness of the board in the MD. (This is discussed in more detail later in the text).

Diagram 2

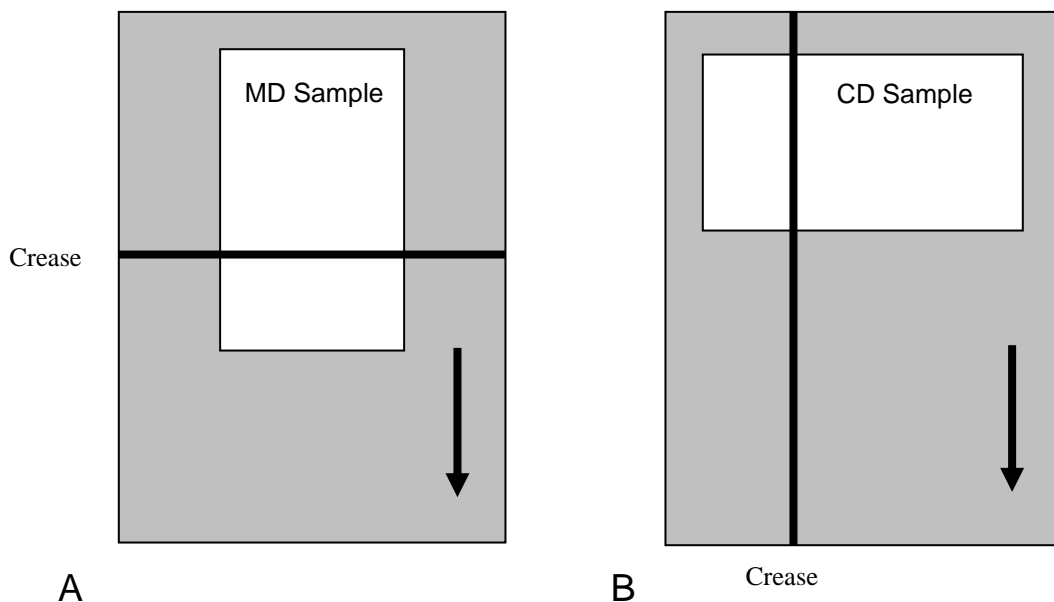

When cutting samples of creased board it is very important that the crease is not folded or bent before the test.

As with board stiffness testing a number of samples should be tested in each direction.

It is recommended that you test MD and CD separately to get accurate results and a crease to board stiffness ratio.

When using the instrument to identify the crease to board stiffness ratio MD board stiffness samples must be tested with MD crease stiffness samples. CD board stiffness samples must be tested with CD crease stiffness samples. More on this subject is below in the section, **Interpretation of results**.

Making a board stiffness test

Remember that board stiffness is measured on a sample 70 mm x 38 mm in size.

Board does not have to be bent through 90°, as creases do, so the stiffness is tested with a much smaller bend of only 15°

Board stiffness differs slightly according to whether it is tested with the liner on the side touching the load bar, or on the other side, so at least five samples must be tested with the liner on the inside, facing the load bar, and five with the liner on the outside.

Fix a sample in the clamp, as shown below. The tester will measure the force with which it presses on the load cell blade when the clamp is rotated through 15°. Before the clamp is rotated, check that the board sticks out straight from the clamp. It should just touch the load cell blade without pushing on it.

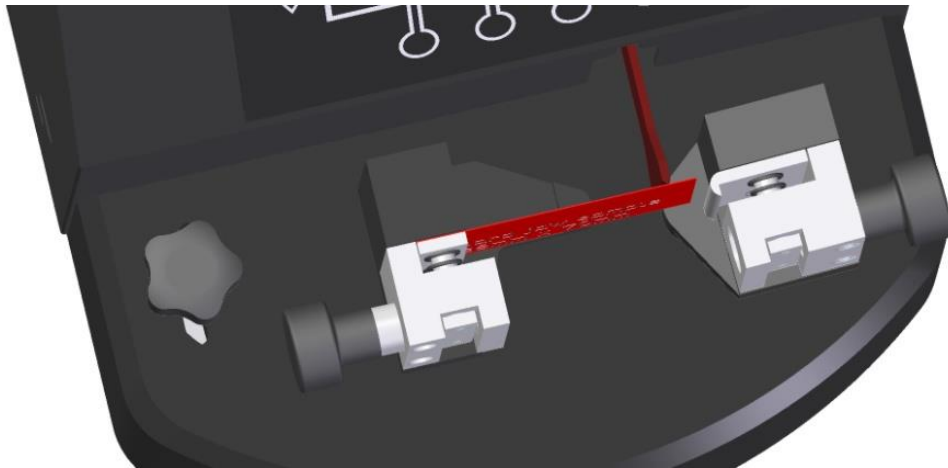

Board Curl Adjustment

Sometimes board is curled. According to which way it is curled, one of two things may happen.

Look at Diagram 5.

It shows that if the board is curled towards the load bar, it will push on it before the Jaw is rotated, and this extra force will give an inaccurate result.

Alternatively, the board may curl away from the load bar as in Diagram 5B, so that it does not touch it. Then, when the jaw is rotated, the board will be bent through less than 15° , and again the result will be incorrect.

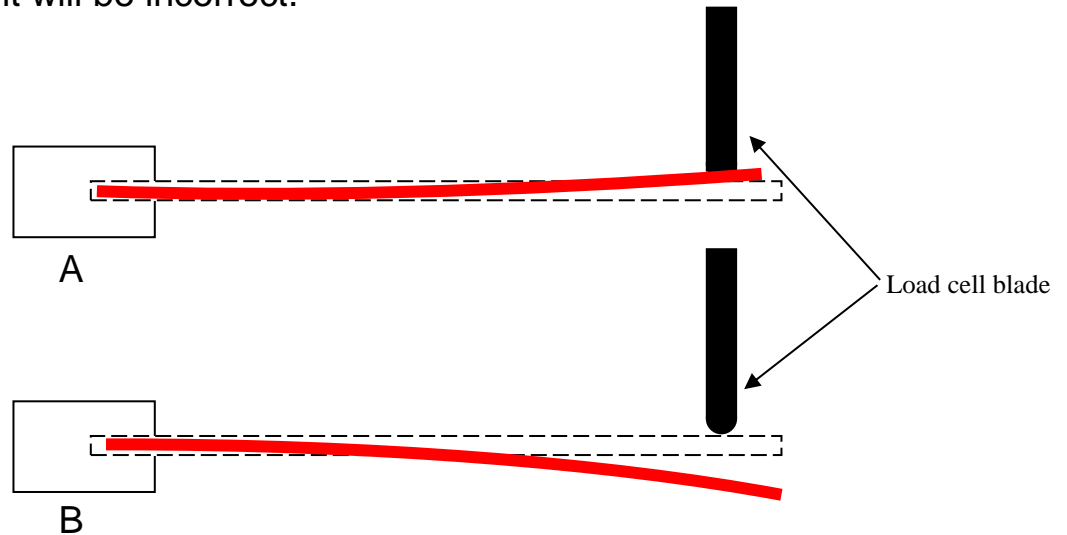
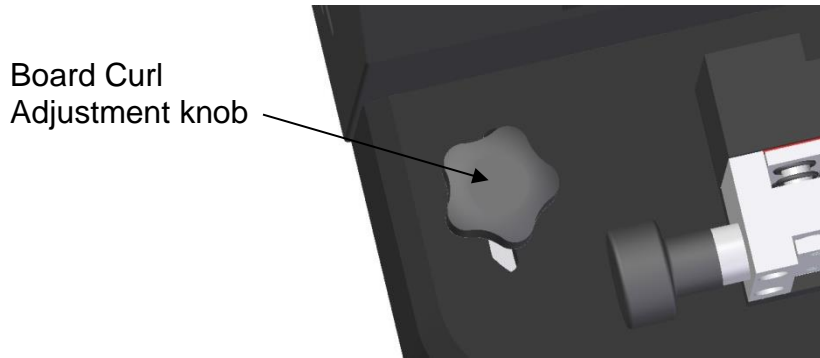

Diagram 5

If either of the above happens, the curl adjustment has to be used. Unscrewing the curl adjustment loosens the clamp, so that it can be turned to bring the board into the correct position for testing. The curl adjustment is then tightened again to lock the rotation angle. The starting position of the clamp will be held like this, but the rotation angle will still be 15° when you start the test.



On each sample, the steps are as set out below. Follow through this procedure on your tester:

- 1 Fix a sample in clamp.
- 2 Check that it is just touching the load cell blade and not pressing on it.
- 3 Make any adjustments if required, loosen the curl adjustment knob and turn the clamp to correct it. Lock the curl adjustment knob.
- 4 The measurement of board stiffness is made by rotation of the LH clamp anti-clockwise through 15° against its stop.

At the end of 15 seconds, the display will stabilise and record the board stiffness.

Repeat the test with the remaining board stiffness samples.

Making a crease stiffness test

The first Step is to put the sample in the clamp. Open the crease jaw clamp by turning the plastic knob a quarter turn either way and insert the larger panel of your sample, making sure that the depression of the crease (the white liner, or the side of the board with a dent in it) is facing towards the load cell blade. Position the sample well into the base and back of the clamp, then close the jaws by turning the winged knob vertical again.

The sample will now be sticking out of the clamp just in front of the edge of the load cell blade.

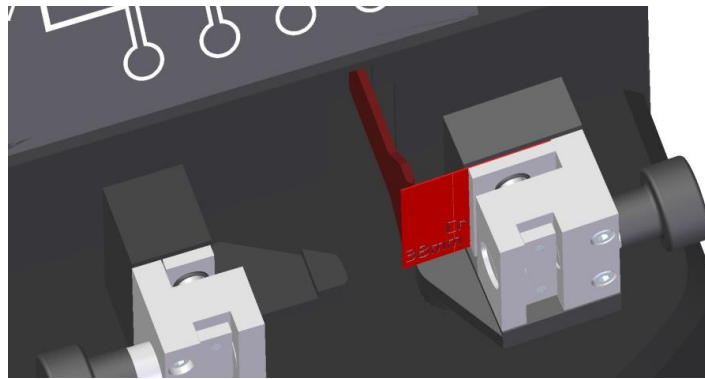

To make the crease stiffness measurement, rotate the clamp clockwise through 90° against its stop, the movement should be made at a speed so that full movement is made within 1 second. The countdown timer will start automatically.

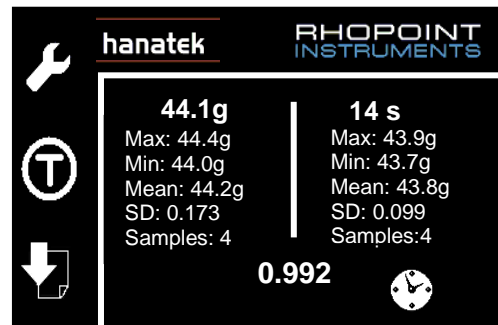
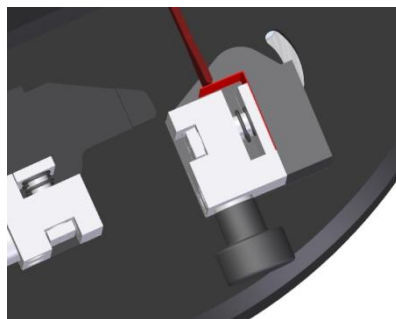

After 15 s, the crease stiffness will be shown.

Interpretation of results

The measurement of board stiffness is made on the Crease and Board Stiffness Tester, generally as required by BS3748: 1964. The British Standard covering the measurement of crease stiffness is BS 6965 Part 1.

The quality of a crease for machine packing can initially be assessed by its appearance. Cracking of the liner or back of the board are obvious defects. An irregular crumpled appearance of the rib on the inside of the fold can also indicate a potentially unsatisfactory crease in carton erection and closure. Even without these visual defects, creases can be too stiff for successful carton performance on the packing line.

Studies by PIRA and other Institutes have shown that the critical factor is the ratio of crease stiffness to board stiffness, both measurements being made in the same grain direction of the board. PIRA packaging line studies have shown that successful carton performance can be anticipated if this ratio of crease/board stiffness is in this range when measurements in g.cm and g are taken directly from the display.

The Hanatek CBT tester automatically calculates the Crease/Board stiffness ratio giving quick and easy analysis or results.

Recommended Ratio

Machine direction	1.5 to 3.0
Cross direction	3.0 to 7.0

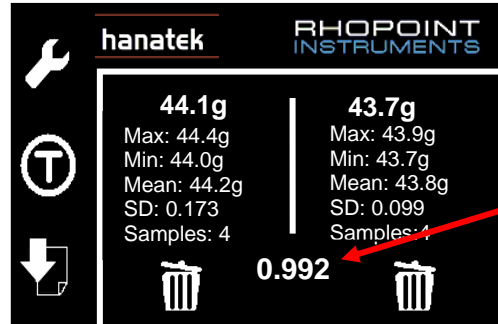

**CREASE TO BOARD
STIFFNESS RATIO**

Packaging machine trials will enable suitable ranges for this ratio to be determined in other situations.

Both board and crease stiffness will change with variations in moisture content. Standard tests are conducted at 23°C, 50% rh. Board in equilibrium with high humidity must be expected to give lower readings.

Should it be necessary to reduce crease stiffness for a particular board, then an optimum crease width should be selected which avoids visual defects in the folds. At this groove width, deeper impressions will reduce crease stiffness.

Exporting Results

The Hanatek CBT instrument has three data export options.

- 1) Export to USB data stick, (*Standard with all instruments*)
Attach a USB drive to the instrument via the supplied Micro USB to USB adapter.

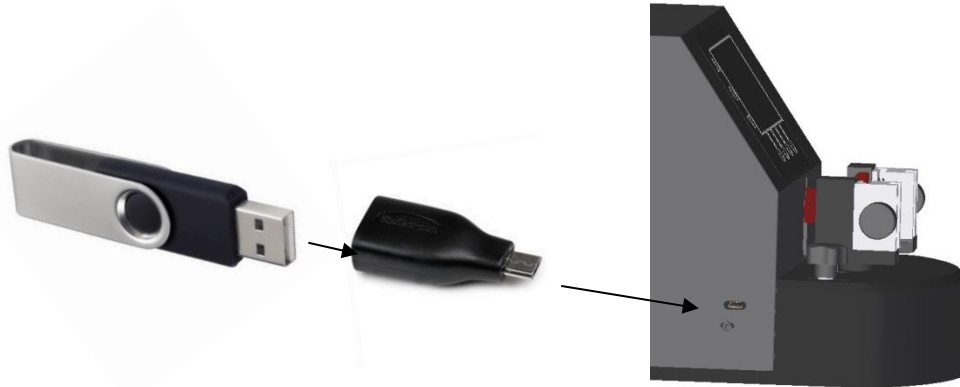

When testing is complete press the data export button. The instrument will beep once to indicate a button press and then again to indicate the file has been sent.

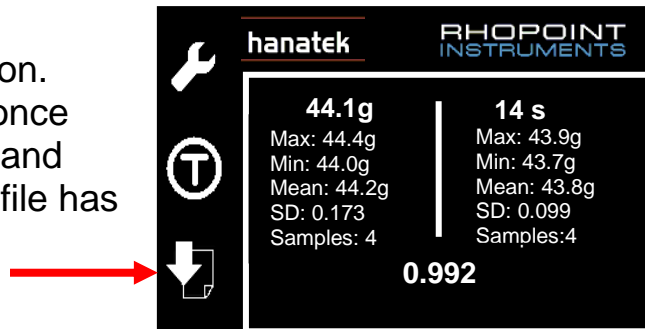

Once the export results button has been pressed the USB stick can be removed from the instrument and plugged into a PC device.

On the USB stick there will be a file named RESULTS. The file is a .csv format that can be opened in most commonly used spread sheet programs.

Date	Time	Serial No	Last Certified	Board samples	Board Max	Board Min	Board Mean	Board SD	Crease samples	Crease Max	Crease Min	Crease Mean	Crease SD	Ratio
Apr 04 2014	12:12:00	CBT120314001A	28/03/2014	4	44.4	44	44.2	0.173	4	43.9	43.7	43.8	0.099	0.992

The above shows an example of an exported results file.

2) Export to results printer, (*optional extra*)

Using a custom data cable and pre-programmed label printer the results from the CBT instrument can be sent directly to a label printer.

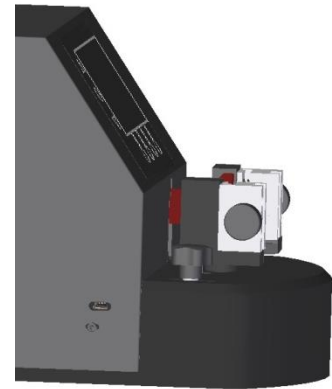

When testing is complete press the data export button. The instrument will beep once to indicate a button press and then again to indicate the data has been sent.

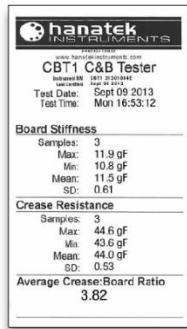

3) Export directly PC, (*optional extra*)

Using a custom data cable and pre-programmed the results from the CBT instrument can be sent directly to a PC program. Most commonly used spread sheet programs are compatible.

Date	Time	Serial No	Last Certified	Board samples	Board Max	Board Min	Board Mean	Board SD	Crease samples	Crease Max	Crease Min	Crease Mean	Crease SD	Ratio
Apr 04 2014	12:12:00	CBT120314001A	28/03/2014	4	44.4	44	44.2	0.173	4	43.9	43.7	43.8	0.099	0.992

The above shows an example of the data sent directly to the PC.

Calibration

The Crease and Board Stiffness Tester will have been dead load calibrated before despatch. In normal use it is only necessary to check the zero reading as described earlier.

Unless a fault or mishandling is suspected, the accuracy of calibration need only be checked once per twelve months when the reading should lie within +/- 1% of the dead load used. It is preferable to have the instrument calibrated by multiple loads across its operating range.

A slotted weight, attached to the underneath of the instrument, is supplied for one-point calibration check purposes. The instrument should carefully be placed in its back and supported with the load blade vertical.

Press tare button to zero the load cell reading.
Place the weight carefully on the load blade and rotate the board jaw, wait for the 15 second timer. The reading shown should match the assigned weight of the calibration check weight +/- 2g.

**REMEMBER TO RE TARE THE INSTRUMENT WHEN IT IS
BACK THE ITS NORMAL OPERATING POSITION.**

In the event of problems, please contact the manufacturers.

Maintenance

The unit is a very robust and technically sound instrument and as such requires little maintenance.

Care must be taken not to bend or damage the load cell as this is the most vulnerable component of the Instrument.

The instrument Calibration should be checked at least once per quarter using the calibration weight supplied.

The instrument must be kept clean at all times.

Service

This can be done by the nearest agent, A list is available on the Hanatek website or please contact Hanatek Instruments using the details below.

The instrument should be serviced and calibrated once per year. This will include the Timer, the program and the load cell performance. The Service will include the instrument being checked for free movement of Jaws and clamps and Light oil will be used if required.

Rhopoint Instruments
Hanatek Instruments
Rhopoint House
Enviro 21 Park
Queensway Avenue South
St Leonards on Sea
TN38 9AG UK

Tel. No. +44 (0)1424 739623
Fax No. +44 (0)1424 730600
sales@hanatekinstruments.com
www.hanatekinstruments.com