



# CONE AND PLATE VISCOMETER

## Operating Manual



## Contents

---

Contents .....	1
1 Safety Instructions .....	2
2 Packing information .....	3
3 Installation information .....	4
4 Introduction .....	5
5 Instrument Operation .....	8
6 Instrument Control .....	10
7 Obtaining good results .....	35
8 Maintenance, cleaning and condition .....	38
9 Specification .....	40
10 Operational accessories .....	42

# 1 Safety Instructions

---

1. Read this operating manual carefully before using the machine.
2. Retain this operating manual for future reference.
3. Observe all safety and warning markings on the machine.
4. Always position the unit on a solid, level surface.
5. This machine must only be used in areas electrically classified as **NON-HAZARDOUS**.
6. Ensure the voltage setting matches your local power supply.
7. The power supply to the instruments IEC inlet socket must be connected to a supply with earth, using the IEC power cord supplied.
8. Safety critical components:
  - a. This machine must be fitted with fuses as specified in this manual and as appropriate to the supplied voltage.
  - b. Any replacement Mains Lead must have an equivalent specification to the one supplied.
9. When operating the machine, remove any loose clothing or jewellery that could become entangled and beware of moving parts.
10. Use normal handling methods taking care when unpacking and lifting the instrument.
11. Do not use excessive amounts of paint or ink, the build-up of which may create a fire hazard.
12. In order to avoid a fire hazard do not use flammable solvents when cleaning the instrument unless absolutely necessary and in any case do not use on front panel or labels.
13. Avoid solvent fumes when cleaning or using the instrument.



Do not dispose of this product with household, commercial or industrial waste. Please refer to local disposal methods or contact us regarding the proper handling of end-of-life electrical and electronic equipment.

Protection is impaired if used in a manner not specified by the manufacturer.

## 2 Packing information

---

The instrument is supplied with smaller items separately packed. Carefully open the top of the packaging before removing the instrument.

1. Identify all the items on the packing list. A copy of the packing list is provided below for reference. Remove the separate items on top. The instrument is protected by a plastic bag that includes desiccant sachets.
2. Remove the top of the packaging and then remove the instrument from the packing case using both hands to lift the base and place securely on the bench before removing the plastic cover. Safely dispose of the desiccant sachets.
3. Refer to the installation instructions.

### *Packing list*

---

The following items will be included:

- Viscometer
- Mains power cable
- Operating handle
- 10 protective front covers
- User manual

## **3** Installation information

---

Please read all the relevant information before attempting installation.

Ensure the instrument is situated on a firm, hard, level surface, strong enough to support its weight without significant vibration and in a well-ventilated area with adequate access to the front and sides. The bench height must allow easy access to the instrument and controls. Keep the left and right ventilation openings in the base free from obstruction.

Remove the operating handle from its separate packaging and screw firmly into the operating lever on the right-hand side.

The instrument uses a universal input voltage power supply.

Use the IEC lead provided to connect to the mains supply. If in doubt, consult a qualified electrician.

The power inlet connector is located on the rear of the instrument's base. The power inlet houses the mains input fuse(s) and mains power switch. Check that the mains switch is off and disconnect the mains plug before connecting the mains lead. Connect the mains plug and then switch the instrument on. The display will light and the instrument will go through a self-test procedure. Allow at least 30 minutes standing-time before use the first time the instrument is switched on (or longer if cold).

## 4 Introduction

---

The Cone and Plate Viscometer was originally designed and developed to measure the dynamic viscosity of paints that are non-Newtonian in behaviour. These types of materials exhibit different viscosities depending on the shear rate applied to them. Application of paints by brush, roller or spray gun, etc. generate shear which also changes viscosity.

Variation in shear rates from  $3000 \text{ s}^{-1}$  to  $15000 \text{ s}^{-1}$  can be expected from normal brush application of paints. A single figure of  $10000 \text{ s}^{-1}$  (BS) or  $12000 \text{ s}^{-1}$  (ASTM) is considered a satisfactory compromise in simulating the effects of brush, roller and spray applications of paints. The cone and plate viscometer was developed in order to reproduce this effect in the laboratory.

The viscosity of other non-Newtonian liquids may be measured on this type of instrument providing careful consideration is given to the shear-rate.

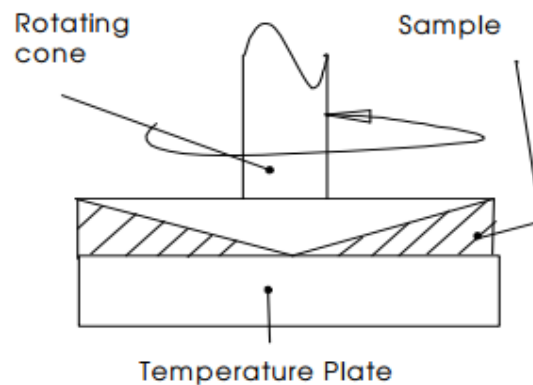

The shear rate (units of  $\text{s}^{-1}$ ) in the liquid under test is dictated by the cone angle ( $\theta$ , units of degrees) and the rotational speed of the cone,  $\omega$  (units of radians.seconds $^{-1}$ ) according to the formula:  $shear\ rate = \frac{\omega}{\tan\theta}$  where  $\omega = \frac{2\pi}{60} \times rpm$

A rotational speed of 750 rpm has been chosen and is specified in BS3900 part A7 2000 (and ISO 2884-1 1999). This speed has proven to give accurate results without generating unwanted heat during the test.

Using this formula, the cone angle required to give a shear rate of 10000 s<sup>-1</sup> at 750 rpm is 0.45° (27'). Paint viscosity measurements are very sensitive to temperature variations and so all tests are conducted under carefully controlled conditions: achieved by providing a temperature controlled plate on which the cone rotates. The test sample is applied to the plate and the cone is lowered onto the plate. Any excess liquid between the plate and the cone is expelled. Both the sample and the cone are kept within the close temperature limits set by the temperature controller in the instrument - time is allowed for thermal equilibrium before the test is started.

The cone is set rotating and the torque (which is directly proportional to viscosity) generated by the motor is measured and displayed.

Note that BS and ASTM standards quote different shear rates in their test methods – 10000 s<sup>-1</sup> for BS3900: part A7: 2000 (and ISO 2884-1 1999), and 12000 s<sup>-1</sup> for ASTM D4287-00

The original cone and plate viscometer (on which these test methods are based) employed a synchronous motor to rotate the cone. With a 50Hz mains electricity supply, the cone will rotate at 750 rpm. Using the same instrument on a 60Hz supply, will cause the motor to rotate at 900 rpm. The CP1 meets both these standards since the speed can be set to either 750 rpm or 900 rpm (independent of mains frequency).

#### *Setting the instrument parameters*

---

The instrument is quite flexible – many of the operating parameters can be set. It is advisable to set the instrument parameters and then enable one of the two security modes - doing this will prevent inadvertent changes.

Viscosity is displayed in centiPoise (cP), Poise (P), milliPascal seconds (mPa.s) or Pascal seconds (Pa.s); the SI unit is Pa.s (or mPa.s). The relationship between these units is –

$$0.1 Pa.s = 1 P = 100cP = 100mPa.s$$

The display units may be selected on the instrument, together with the display resolution. A time of 15 seconds is a good value for both preheat and run times for the CP1. Allow at least 30 seconds (with a hot cone) for the sample to stabilise at the higher temperatures; shorter times may be used at the low end of the temperature range. Once you are familiar with instrument operation, decide on whether manual operation or automatic operation is best suited to your needs.



## 5 Instrument Operation

---

Using the cone for your viscosity range, turn the instrument on and allow the plate to reach the set temperature. After a short time the instrument will display

**\*\* Ready \*\***

Ensure that the cone value is correctly set (see top right of LCD).

The instrument is then available for use with the default settings supplied.

### *Taking a measurement*

---

- Ensure the cone and plate are clean.
- Place a small amount of material to be tested on the plate (see later for recommended sample volumes).
- Lower the cone GENTLY and fully onto the plate – any excess material will flow out from the side of the cone. The time taken for the cone and sample to reach the plate temperature will depend on the sample and ambient temperature. At least 15 seconds should be allowed and longer if the sample temperature is significantly different (this can be timed automatically).
- Press the start switch.
- Allow the instrument to run for the pre-set run time. The result is displayed on the screen until the next run is started.
- Record the result as required.
- Raise the head and clean the cone and plate.
- Lower the plate onto the cone to keep it at the plate temperature before the next test.

## Changing and inserting cones

---

Fit a CP1 cone to the instrument as shown below –

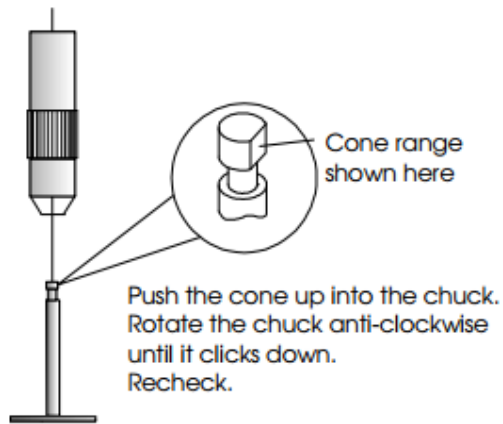

## Overload Error

---

The instrument measures the torque applied to the rotating cone and automatically halts (displaying an overload error) if the torque value exceeds the maximum allowed.

## 6 Instrument Control

---

The following sections describe the instrument controls and menu operation.

### *Operating handle*

---

The handle moves the cone up and down. A sensor detects when the cone is lowered onto the plate. Operation may be set to manual or automatic (handle operated).

### *Mains power socket*

---

A detachable power lead is provided. Only use this lead to connect to the instrument. A plug must be used to connect the instrument to the mains supply. The mains supply must be earthed.

### *Power indication*

---

The rocker switch on the mains inlet is used to switch the mains power on and off. The switch must be ON (indicated by the '1' position) before the instrument can be operated. The backlight on the display will operate when power is applied.

### *Controls*

---

The control panel is located at the front of the instrument. It contains a LCD display, 5 keys and a LED.

The three keys to the right of the LCD display are used to set instrument conditions. These are 'soft-keys' since they perform the function displayed to the left of them on the LCD display. The bottom (of the three) keys is also used to start (and stop the instrument) and to spin the cone for cleaning after a run - this operation will be described later. The two keys below the display are used to increase or decrease a set value once a menu option has been selected.

The operating handle is used to lower and raise the cone. The handle operates a sensor when the cone is close to or touching the plate. The instrument may be set to use the handle to lower the head (with a manual start) or to operate automatically.

It is possible to select auto-spin (after a measurement) to allow the cone to be cleaned when the handle is raised. The various modes of operation will be described later.

### *Auxiliary Start/Stop switch*

---

An additional start/stop (and spin) switch is located on the right-hand side of the base. This switch performs the same function as the bottom right-hand display switch. These switches may be used interchangeably to start and stop the instrument.

### *LED*

---

The front panel also has a bi-colour LED that indicates the state of the instrument.

The instrument may be started any time the LED is green; the LED will flash when the instrument is running. Operation is not possible when the LED is orange or red.

The LED is orange during periods when the instrument is on, but may not be used – for example, after the temperature has just been changed or while a menu item is selected. The LED is red during power-on diagnostics. The led will flash red when an error condition is detected (such as motor overload).

### *LCD Display*

---

The LCD display indicates the current state of the instrument – see below (this example shows the instrument is at temperature and ready to run).

The actual plate temperature (in °C) is shown at the top left of the LCD. The currently selected cone is shown at the top right. The time and date are displayed on the bottom line. The central shaded message box displays instrument readiness.

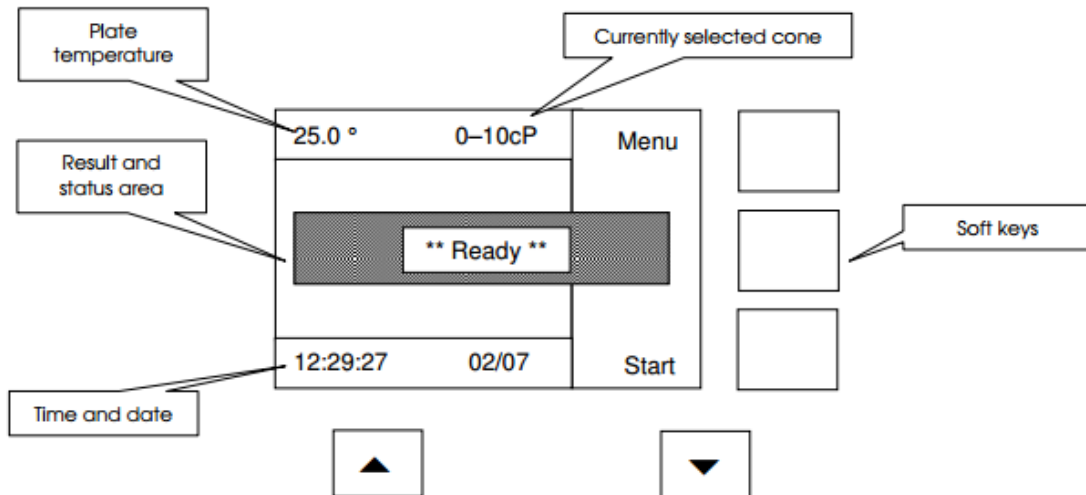

The text displayed next to the three right-hand switches varies from display to display; pressing the switch next to the 'soft-key' will select the function displayed. Using the example above, pressing the top right key will select the instrument menu and the bottom right key will start the instrument.

Once a result has been recorded, the display will look similar to the one below. The Sample id is shown in brackets underneath the result. The Sample id is automatically incremented after each result. The x (top left of the result) will only be displayed if the run was halted prematurely.

The LCD display backlight will dim after 10 minutes when the instrument is not being used. Press any key to restore the backlight.

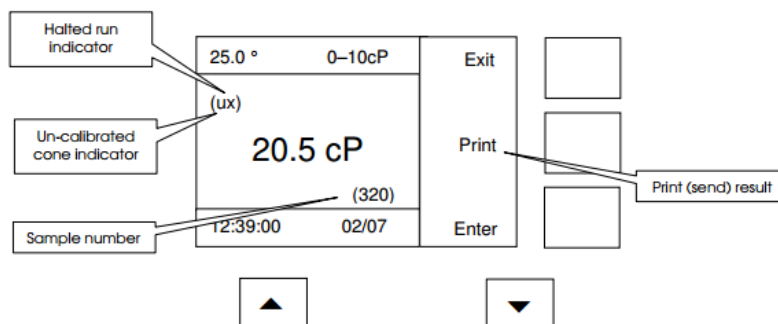

The **Print** key becomes visible once a result has been taken (manual mode only). Print (after result) is always enabled when the instrument is in automatic mode. Results are always printed in cP (mPas).

Protective front covers slot into the holder on the front of the head. Use these to prevent contamination of the display; replacement covers are available.

### Operation

---

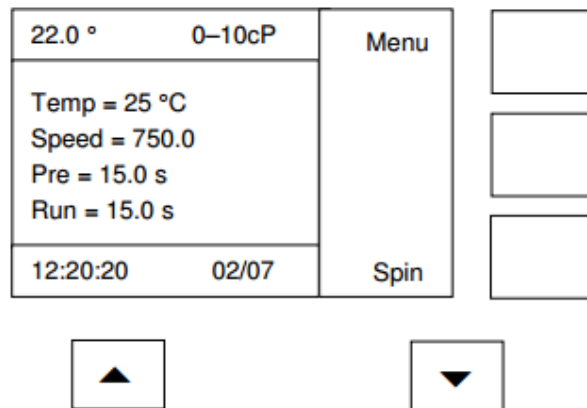

After the instrument is switched on, the software version number is immediately displayed, followed by the instrument type. The instrument then performs a power-on check. Several internal checks are made on memory, the supply voltages and the clock-battery; the results are displayed.

The instrument then displays a status screen (similar to the one below). This screen shows the current settings for the instrument.

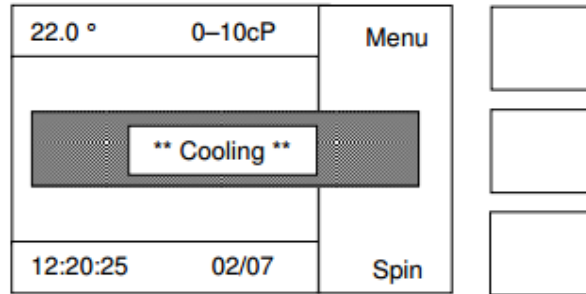

The display will change to one similar to the one shown below a few seconds later. The temperature (top left of the LCD) will flash on and off until the plate reaches the set temperature within its ready band (default  $\pm 0.1$  °C). The instrument will be usable once the temperature has fallen within the ready band.



About 20   seconds later (after allowing the plate temperature to stabilise) the display will change to the one below (assuming the operating handle is up).

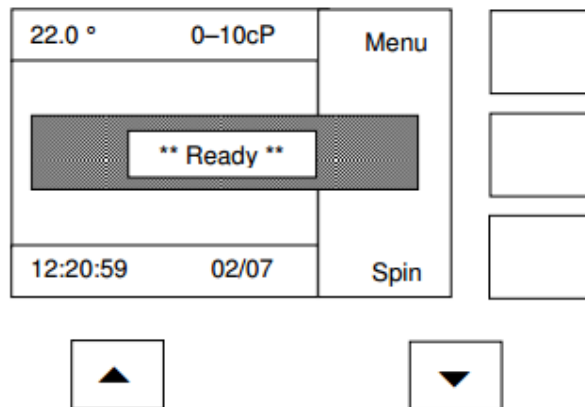

The bottom right-hand key indicates that the cone can be rotated to aid cleaning (since the handle is up at this point).

Alternatively, if the handle is down, the display will show Start instead of Spin against the bottom right-hand key. See below:

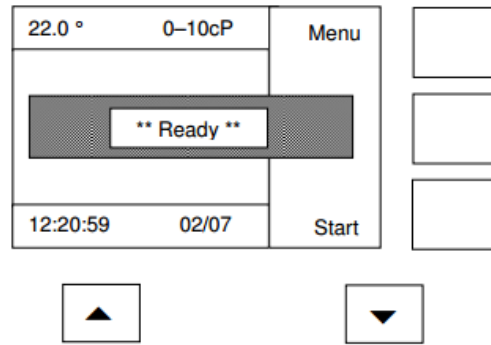

The menu key (top right) is used to access and set various operating parameters - for example, operating temperature. Once the instrument has been set to the required operating conditions, the menu will rarely need accessing.

Pressing the menu key will produce the display shown below. The right arrow is initially positioned next to (highlighting) Batch. The down arrow shown on the display as a prompt, indicating that this key is now active.

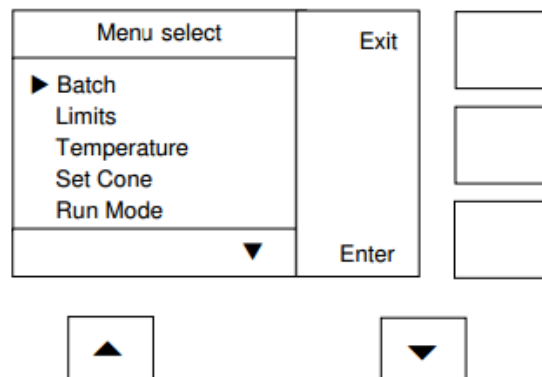

Pressing the down key moves the select arrow down by one line and the screen below will be displayed. The up arrow prompt will appear on the bottom line, showing that the up arrow key is available to move the select arrow back up. Thus the up and down keys are used to move up and down through the menu system. There are more than five menu items and once the bottom of the screen has been reached, the display will continue to scroll down. The full menu items available are:

Batch, Limits, Temperature, Set cone, Run mode, Preheat time, Run time, Settings, Contrast, Speed, Preferences, Calibration, Time/Date, Diagnostics



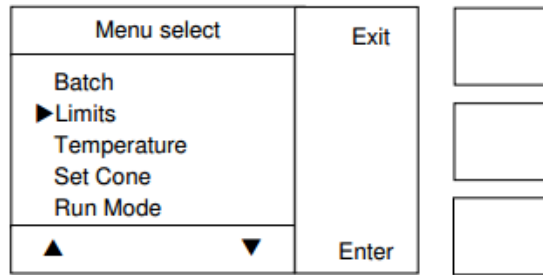

Pressing the Exit   (top right key) will return to normal display screen without changing anything. Pressing the Enter (bottom right key) will select the highlighted menu item. For example, if the key is pressed once more, Temperature will be highlighted and pressing the enter key will give (CP1 example)

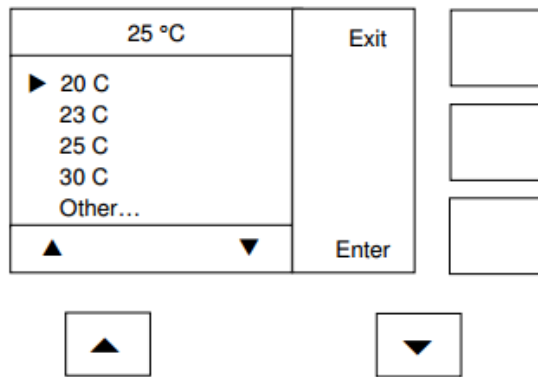

Each line can be selected using the up and down keys. Pressing the down key four times will highlight **Other**. Pressing the Enter key will cause the following screen to appear.

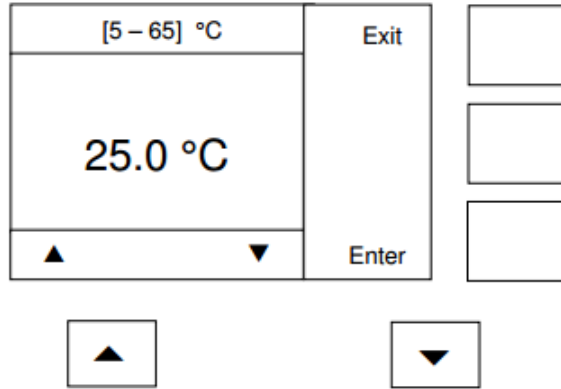

The up and down keys can now be used to alter the set temperature. The up key will increase the value and the down key will decrease it. The top line indicates that the temperature can be set anywhere between 5 °C and 65 °C. As the up key is pressed, the new value increases. When the value reaches 65 °C the next key press will wrap around to 5 °C. Similarly when using the down key, the next value after 5 °C is 65 °C. Pressing the **Enter** key will select the new value and pressing the Exit key will leave the current value unchanged.

All menus operate in the same way. Each menu is described in more detail below in the order it appears in the menu list.

*Batch Menu*

---

The following screen appears once the Batch menu has been selected:

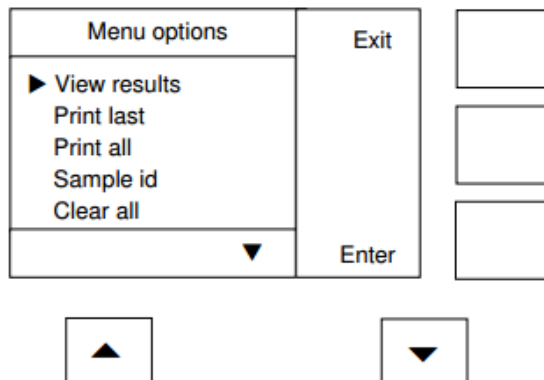

### View Results

---

This menu option allows any results from previous runs to be viewed. Up to 100 results are recorded. When the memory is full the oldest run will be overwritten.

Selecting this option will show a display similar to the following screen, with the sample number followed by the result.

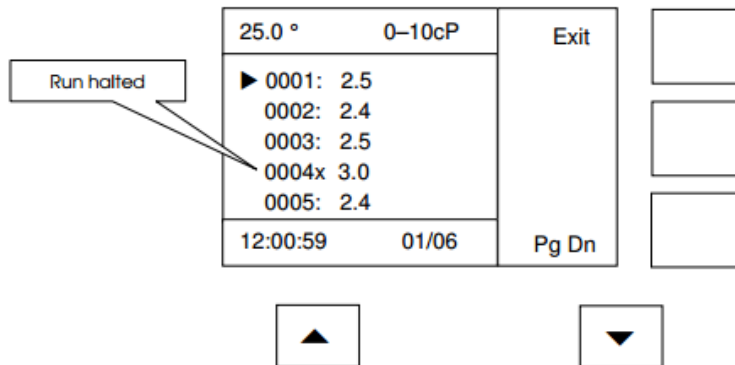

In this case, the temperature, cone, date and time refer to the highlighted line, so as the select arrow is moved down, these values change showing the results recorded for that run. The 'x' on the fourth line indicates that the run was halted prematurely. When limits are enabled, any result outside the pre-set limit values will be shown in reverse video.

The up and down keys are used to highlight one of the five values displayed. The **Pg Dn** softkey is used to display the next five results (when there are more than five results). A **Pg Up** key will appear next to the centre key when the **Pg Dn** key is used. The **Exit** key is used to return to normal operation.

### Print last

---

This menu option sends the last result taken to an attached PC. The exact format depends on the option selected (see options menu). A terminal program is required (several are available on the Web). Results are always printed in cP (mPas).

### Print all

---

This menu option sends all the stored results (always in cP/mPas) from all previous runs to an attached PC12. The exact format depends on the option selected (see options menu).

*Sample id*

---

This menu option allows the sample id to be set to any value between 0 and 999 (set to 316 here). The sample id is associated with the current result (before being incremented).

[0 - 999]	Exit	<input type="checkbox"/>
316		<input type="checkbox"/>
▲ ▼	Enter	<input type="checkbox"/>

<input type="checkbox"/> ▲	<input type="checkbox"/> ▼
----------------------------	----------------------------

The up and down keys are used to select a new value. The **Enter** key is used to set the new value. The **Exit** key is used to return to normal operation without altering the current value.

Note that the **Clear all** menu option, described below, resets this value to 0.

*Clear all*

---

This menu option allows the saved results and sample id to be reset to 0.

Clear memory?	No	<input type="checkbox"/>
Are you sure?		<input type="checkbox"/>
12:20:59    02/07	Yes	<input type="checkbox"/>

Selecting **Yes** will clear all the stored results and reset the sample id to 0. Selecting **No** will leave the results and Sample id unchanged.

## Limits menu

---

The following screen appears once the **Limits** menu has been selected. The top line shows that limits are currently on.

This function is useful in batch mode in a production environment where a large number of samples are tested against a pre-set limit.

The first two options, **Limits on** and **Limits off** allow limits to be turned on or off. Limits are based on an 'ideal' value and a  $\pm$  percentage difference. The result will be shown in reverse video when it is outside the preset limit (and limits are turned on). The top line displays the current setting. The centre (ideal) value is set using the **Value** menu and the limit range using the **Percent** menus as described below.

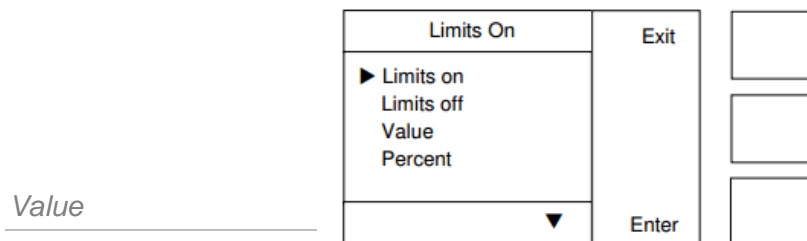

This menu option allows the centre value to be set; this is the 'ideal' (or centre) value for the product.

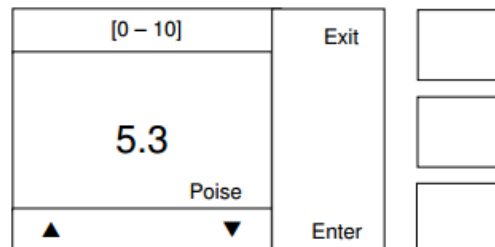

## Percent

---

This menu option allows the percentage difference ( $\pm$  on the ideal value) to be set between 1% and 10% of the centre value.

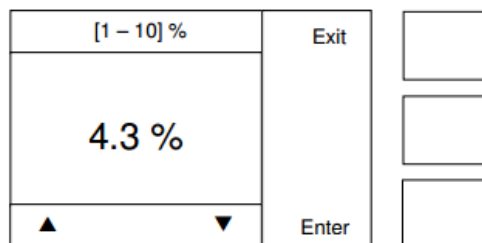

### Temperature menu

---

#### CP1 temperature display

The following screen appears once the CP1 **Temperature** menu has been selected. The top line shows the current set temperature.

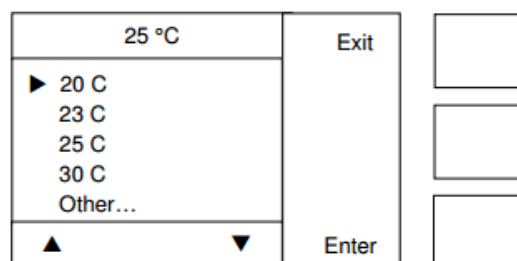

Use the keys to select one of the four pre-set values. Alternatively, the temperature may be set to any value between 5°C and 65°C in 0.1°C increments when the **Other** menu is selected (see the next section). Select **Enter** once the required temperature has been chosen. The instrument will quickly change to the new set-point. Once the new set-point has been reached, a delay of 20 seconds is used to allow the plate surface-temperature to reach the precise set point.

### Other

---

The menu option allows the temperature to be set to any value between minimum and maximum temperature limits in 0.1°C increments.

### Set cone menu

---

The following screen appears once the **Set cone** menu has been selected. The top line shows the current cone selected. Please note that the instrument does not detect the cone currently fitted – it is always necessary to use this menu when the cone is

changed. The main screen always shows the currently selected cone. A warning will appear on the display if the newly selected cone is not calibrated.

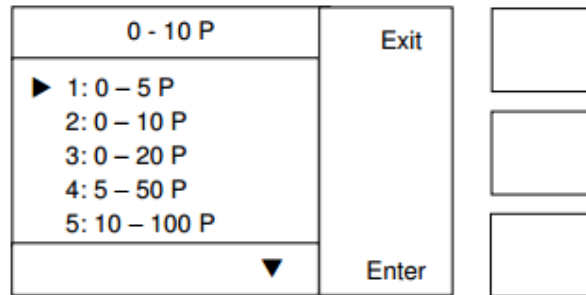

Use the keys to select one of the five cones listed here as the current fitted cone.

*Run mode menu*

---

The following screen appears once the **Run mode** menu has been selected. This menu allows the instruments' operating mode to be set. The first option allows the instrument to be started manually or automatically. The second option allows the instrument to be set to report the viscosity value at the peak or as a timed value.

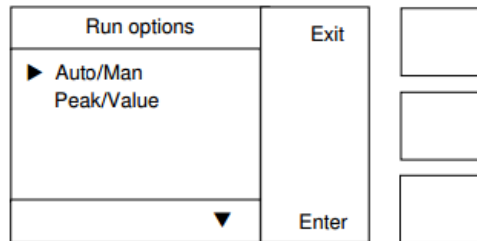

For example, selecting displays the following displays the current setting):

the first line option screen (the top line

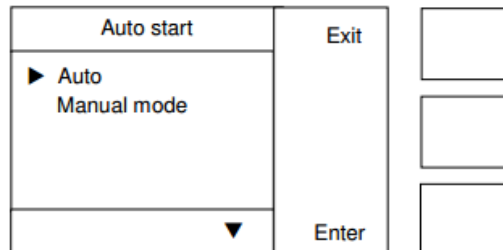

*Automatic*

---

When automatic mode is selected, the instrument will operate from the handle sensor. The sensor detects that the cone has been lowered onto the plate and automatically

starts the run. Raising (once the run has finished) and lowering the handle again will start another run. Raising the handle once the measurement is underway will halt the run. Note that the start key(s) will also halt the current run before it completes normally.

This mode of operation is convenient when a large number of samples are to be tested and prevents paints and solvents being transferred to the front of the instrument. The result is always transmitted to the PC interface in this mode. This mode is not recommended for the CP2 where time is required for the plate to thermally stabilise.

### *Manual run*

---

When manual mode is selected, the instrument will operate from either the **Start** key on the LCD screen or the mechanical key on the right-hand side of the base. Note that the cone must be lowered onto the plate before this option is available. The run starts when the key is pressed. Pressing the key again before the run completes will halt the run.

### *Continuous/Peak mode*

---

Selecting the second line option displays the following screen:

Continuous	Exit	<input type="checkbox"/>
▶ Continuous Peak mode		<input type="checkbox"/>
▼	Enter	<input type="checkbox"/>

The top line displays the current setting. Select **Continuous** mode (default) to report the viscosity value at the end of the run time or select **Peak mode** to report the maximum (peak) viscosity value (at the end of the run time).



### Preheat time menu

---

The following screen appears once the **Preheat time** menu has been selected. The top line shows the current preheat time. The preheat time is used to set the amount of time the cone is stationary on the plate before the run starts. This allows both the cone and sample to reach thermal equilibrium before the run. The time to equilibrium will depend on the cone and sample temperature and the temperature difference between these and the plate. Operation around ambient temperature will require less time than, for example, with a plate set at 5 °C (or 240 °C).

15.0 s	Exit	<input type="text"/>
▶ Off		<input type="text"/>
10 sec (15 sec CP2)		
15 sec (30 sec CP2)		
30 sec (60 sec CP2)		
Other...		
▼	Enter	<input type="text"/>

The top line displays the current setting. The values shown are for the CP1 (the values for the CP2 are shown in brackets). Use the keys to select one of the five options available. The **Other** menu allows any time between 1 and 59 seconds for the CP1 (or 1 and 999 seconds for the CP2). The time is set in 1 second increments.

### Run time menu

---

The following screen appears once the Run time menu has been selected. The top line shows the current run time. The run time is used to set the amount of time the cone rotates once the instrument starts. The top line displays the current setting.

15.0 s	Exit	<input type="text"/>
▶ 5 sec		<input type="text"/>
8 sec		
10 sec		
15 sec		
Other...		
▼	Enter	<input type="text"/>

Use the keys to select one of the five options available. The **Other** menu allows any time between 5 and 59 seconds to be set (in 1 second increments). This time should always be at least 15 seconds.

### Settings menu

---

A screen, similar to the following one, will appear once the **Settings** menu has been selected. The currently set instrument conditions are displayed.

0-10cP	Exit	<input type="checkbox"/>
Temp = 25 °C Speed = 750.0 Pre = 15.0 s Run = 15.0 s CP1 - Cont		<input type="checkbox"/>
12:20:20      02/07	More	<input type="checkbox"/>

Press the **More** key to view the next screen.

### Contrast menu

---

The following screen appears once the **Contrast** menu has been selected. Use the up and down keys to alter the contrast. The solid bar indicates the current contrast value.

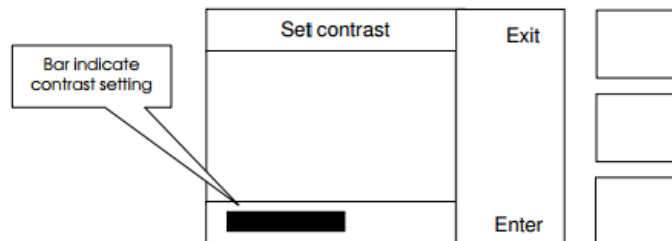

### Speed menu

---

The following screen appears once the **Speed** menu has been selected. The top line shows the current selected speed. Generally 750 rpm is used in Europe (ISO and BS

standards) and 900 rpm in the USA (ASTM standard). Select the rotational speed required.

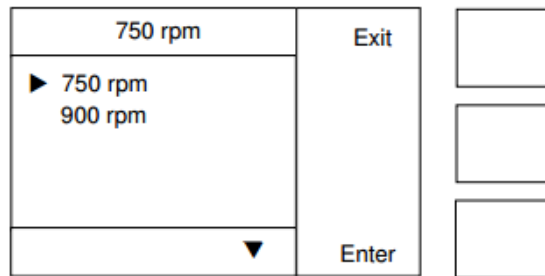

### Preferences menu

---

The following screen appears once the **Preferences** menu has been selected. This menu allows various operating preferences to be set. There are more than 5 options; use the scroll keys to access the additional items.

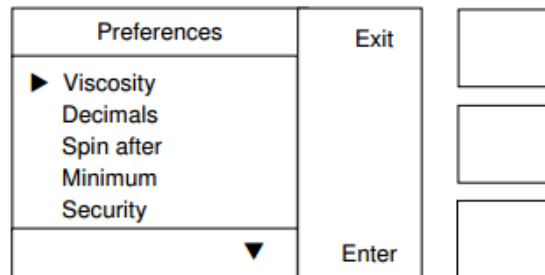

The following appear once the screen is scrolled beyond the first 6 options.

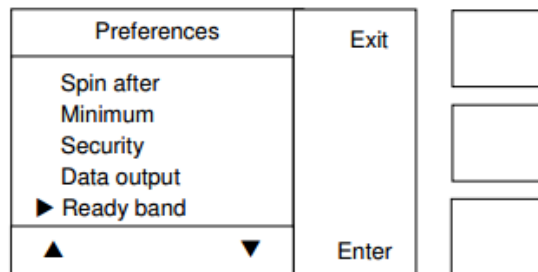

### Viscosity

---

The following screen appears once the **Viscosity** menu has been selected. This allows the instruments' operating units to be set.

Units	Exit	<input type="text"/>
▶ cP mPa.s Pa.s Poise P		
▼	Enter	<input type="text"/>

### Decimals

---

The following screen appears once the **Decimals** menu has been selected. This allows the displayed resolution to be set. This setting does not affect the data output.

Decimal places	Exit	<input type="text"/>
▶ Zero places One place Two places Three places		
▼	Enter	<input type="text"/>

### Spin after

---

The following screen appears once the **Spin after** menu has been selected. The spin after option (when enabled) causes the cone to spin automatically after a run (2 seconds after the handle has been raised). If no load is seen, then the spin will stop after 5 seconds. If a load is seen (due to cleaning), then the cone will continue spinning until a few seconds after the load is removed.

Set on/off	Exit	<input type="text"/>
▶ On Off		
▼	Enter	<input type="text"/>

## Minimum

---

The following screen appears once the **Minimum** menu has been selected. Once enabled, the minimum value during a run will be displayed on the result screen.

Set on/off	Exit	<input type="text"/>
▶ On Off		<input type="text"/>
	Enter	<input type="text"/>

## Security

---

The following screen appears once the **Security** menu has been selected. Two security modes are available.

### Medium security

Enter a code of 99 to enable medium-security mode (set on).

In medium-security mode, the number of options available from the **Menu** is reduced to:

#### Batch, Temperature and Security

This mode prevents most inadvertent changes to the instrument settings. Only the temperature can be changed and the batch values and sample number set/cleared.

### High security

Enter a code of 47 to enable high-security mode (set on).

In high-security mode, the number of options available from the Menu is reduced to just:

#### Batch and Security

Batch menu options are also restricted to viewing-only in high-security mode. This mode totally prevents any inadvertent changes to the instrument settings.

Set on/off	Exit	<input type="text"/>
▶ On Off		<input type="text"/>
▼	Enter	<input type="text"/>

Once the instrument is in secure mode, other menu modes can be enabled/disabled by selecting **Security** and re-entering the code, 99 or 47. Note that both security modes are available at the same time with the highest security mode taking precedence.

### Data output

The following screen appears once the **Data output** menu has been selected. This allows the data output mode options to be set.

Data output	Exit	<input type="text"/>
▶ On result On key press Result only Full data Mini printer		<input type="text"/>
▼	Enter	<input type="text"/>

**On result** selecting this causes the data to be automatically output every time a measurement is taken (default)

**On key press** data is output either singly or in total on demand from the batch menu

**Result only** selecting this causes only the result to be output (default)

**Full data** selecting this causes the result and test conditions to be output (mini-printer format not affected when selected)

**Mini printer** selecting this causes displays an additional menu that allows an attached mini printer to be enabled or disabled. When enabled, the data format is adjusted for the mini printer

See the data format section for more details.

### *Ready band*

---

The following screen appears once the **Ready band** menu has been selected. This allows the ready band temperature for the instrument to be set. The ready band temperature defines the band (either side of the set point) in which the instrument can be used. A sample run cannot be started when the temperature is outside the band). For example, setting a ready band of  $\pm 0.5^{\circ}\text{C}$  with a set temperature of  $25^{\circ}\text{C}$ , means the instrument cannot be used when the temperature is below  $24.5^{\circ}\text{C}$  or above  $25.5^{\circ}\text{C}$ .

Data output	Exit	<input type="text"/>
▶ 0.1 C		
0.2 C		<input type="text"/>
0.5 C		
1.0 C		
Off		
▼	Enter	<input type="text"/>

Note that the temperature (shown at the top-left of the display) will flash when the plate temperature is more than the ready band temperature-difference away from the set temperature.

### *Calibration menu*

---

The following screen appears once the **Calibration** menu has been selected.

Calibrate	Exit	<input type="text"/>
▶ Viscosity		
Temperature		<input type="text"/>
Options		
▼	Enter	<input type="text"/>

Choose either viscosity (torque measurement) or plate temperature calibration. The options section allows the calibration time to be altered from the default 20 seconds value.

### *Temperature calibration*

---

The instrument is calibrated before delivery and will not normally need recalibrating outside the regular service intervals. The following screen appears once the **Temperature** menu has been selected (after the correct security code has been entered).

#### **CP1 temperature calibration screen**

Calibrate	Exit	<input type="text"/>
▶ 5 °C cal 25 °C cal 60 °C cal All three...		<input type="text"/>
▼	Enter	<input type="text"/>

If you work at one or near one of these 3 temperatures, it is only necessary to calibrate the instrument at that temperature. Measurement at any other temperature requires temperature calibration either side of the working temperature – for example if you use a temperature between 5 °C and 25 °C, calibrate the instrument at 5° C and 25 °C (calibration at 60 °C will be unnecessary in this case). The calibration process can be accepted or rejected at the end. Each temperature is calibrated separately. Follow the on-screen instructions once one of these temperatures has been selected. Temperatures can be calibrated individually or all three can be calibrated in one sequence.

### *Viscosity calibration*

---

The instrument is calibrated before delivery and will not normally need recalibrating outside the regular service intervals.

The following screen appears once the Viscosity menu has been selected. First choose which cone you want to calibrate.



Cone	Exit	
▶ Cone 1 0 - 5		<input type="text"/>
Cone 2 0 - 10		<input type="text"/>
Cone 3 0 - 20		<input type="text"/>
Cone 4 5 - 50		<input type="text"/>
Cone 5 10 - 100		<input type="text"/>
▼	Enter	<input type="text"/>

There are 5 possible cones to choose from. Each cone is calibrated separately with 5 oils at a temperature of 25°C for the CP1 (temperature is set automatically during the calibration process). Separate instructions screens follow to lead you through the calibration process - read and follow the instructions on each screen. The whole calibration process can be accepted or rejected at the end. To summarise the process steps:

1. Start the viscosity calibration
2. Select which cone you want to calibrate
3. Follow the on-screen instructions
4. Check the oil calibration values. Change if necessary. These will be held in memory for next time
5. Wait for the plate to reach temperature
6. Run the calibration step and proceed to the next. Use the recommended oil volumes
7. Accept the calibration at the end of the procedure.

It is possible to skip calibration with any of the oils. However, the cone will not register as calibrated until all oils have been used (the option to just set the zero calibration point will be offered when all oil calibration values have been skipped).

Calibration values are checked at the end of the procedure to ensure that they are in the correct order; no other checks are performed. It is sensible to run the calibration oils once the procedure has been finished to check the procedure has been carried out correctly. Possible sources of error are (in decreasing order of effect):

- Incorrect oil used
- Insufficient temperature stabilisation time

- Oil contamination
- Incorrect volume used
- Incorrect cone used (may or may not calibrate successfully)

The currently selected viscosity units are used to change the calibration oil values.

### *Calibration options*

---

The instrument is normally calibrated with a 20 second run-time. Other calibration run-times can be set by selecting the options menu.

Once the **Options** screen has been selected enter a safety-code of 291 to allow the calibration run-time to be altered. Once the correct code has been entered, the following screen will appear:

Other calibration run-times can now be entered. A non-standard calibration run time will result in a warning being given before calibration is started.

[5 – 59]	Exit	<input type="text"/>
8.0		<input type="text"/>
▲ ▼	Enter	<input type="text"/>

### *Time/Date menu*

---

The following screen appears once the **Time/Date** menu has been selected.

Time/Date	Exit	<input type="text"/>
▶ Set time Set date		<input type="text"/>
▼	Enter	<input type="text"/>

The option is used to set the system time and date.

## 7 Obtaining good results

---

The Sheen Cone & Plate will give accurate and repeatable results provided a few simple precautions are observed:

- Always ensure that the cone and plate are clean and free from damage
- Always allow enough time for the cone and sample to reach thermal equilibrium before starting the run
- Try to use the same sample volume every time
- Avoid using samples with viscosities significantly above or below the calibration oil range. Change cone when this is necessary
- Check calibration before and after use daily. Use a calibration oil to do this
- Avoid draughts in the sample area
- Never under-fill the cone

The largest source of error is usually due to the variation in sample volume. Under filling the cone will result in very large variations in the result. Over-filling produces less variation, but is still significant.

### *Sampling mode*

---

Two different modes of operation are available – Normal Mode and Peak Mode. The choice of measurement mode depends on the sample and its rheological properties:

- **Newtonian** materials. Either mode may be used since viscosity is essentially independent of run-time. However, use Normal Mode in preference since this will always give the result from the same fixed run-time
- **Non-Newtonian thixotropic** materials. The apparent viscosity decreases with runtime. It may be more appropriate to measure these using Peak Mode (the maximum viscosity measurement is held)
- **Non-Newtonian rheopectic** materials. The apparent viscosity increases with runtime. Use Normal Mode and enable minimum value. Record the result as required

### Measurement accuracy and repeatability

---

The measurement accuracy depends on the factors listed above. The figures quoted below assume the instrument is used within the normal calibrated range. Useful cone ranges and the sample volumes are shown below:

For a given set of operating conditions, repeatability is  $\pm 0.5\%$ , assuming the same sample volume is used every time.

Cone (range)	Recommended Sample volume ( $\mu\text{l}$ )	Accuracy (% of full scale range)
1 (0.5 – 5.5 P)	50	$\pm 2.0\%$
2 (1.0 – 11 P)	30	
3 (2.0 – 21 P)	50	
4 (5.0 – 60 P)	80	
5 (10 – 110 P)	40	

### Temperature accuracy

---

Temperature <sup>24</sup>	Accuracy	Resolution
Less than ambient plus 15 °C	Unspecified	
Ambient plus 15 °C to 240 °C	$\pm 0.2$ °C or better	

### Disabling heating/cooling at switch-on

---

After switch-on, the instrument will control the plate temperature at the previously set value. It may be desirable (particularly in the case of the CP2) to prevent the temperature control system from doing this.

Take the example of the CP2 being switched off (when the plate temperature was set to 200°C) and switched on again next day, If it is now necessary to run a sample at

60 °C, it will take some time for the temperature to be changed and the plate to cool. The instrument contains a means of disabling the heating/cooling system at start-up

1. Before switching on, press the start button on the base of the instrument
2. Turn on the mains power, keeping the button depressed
3. Release the button after at least 1 second

The heating/cooling system is now disabled; it will be (permanently) re-enabled on the next press of the button.

## **8** Maintenance, cleaning and condition

---

The Sheen Cone & Plate instruments will give good and reliable service if it properly maintained. Certain procedures must be carried out at the intervals shown below. Trained service personnel must carry out all other maintenance.

The instrument is guaranteed for twelve months against failure due to defective materials or components, conditional upon the maintenance schedules below being carried out at the specified intervals.

### *Maintenance schedule*

---

To ensure that repeatable results are obtained:

#### *Between tests*

Clean the cone and plate (and vapour trap, if fitted) thoroughly after each test.

#### *Daily*

Check the mains power cable condition. Use the calibration oils to check the performance before and after a day's set of measurements.

#### *Weekly*

Check the instrument, cone and plate for wear or damage.

#### *Yearly*

CP1 must be serviced and calibrated by a trained and qualified service engineer.

### *Cleaning*

---

Take care to only do this after the mains cable has been removed from the instrument.

Do not use solvent to clean the instrument (apart from the cone and plate). Painted surfaces may be cleaned with a slightly damp cloth & mild detergent solution.

Clean the cone and plate with a suitable solvent and a non-abrasive cloth.

### *Fuse replacement*

---

Switch the instrument off and remove the mains cable from the rear of the instrument.

The fuse holder is located on the mains power-inlet.

Carefully release the holder (use a small screwdriver) and gently pull the fuse housing outwards.

Remove and replace the fuse with the exact equivalent 2A (T) Antisurge.

Gently push the fuse holder into its housing and reconnect the instrument.



## 9 Specification

---

### INSTRUMENT DETAILS:

<b>CP1 Plate temperature</b>	5°C (or maximum of 20°C below ambient) to 65°C (in 0.1°C steps)
<b>Temperature resolution</b>	±0.1 °C
<b>CP1 temperature control</b>	±0.1 °C (calibrated)
<b>CP1 temperature accuracy</b>	±0.1°C (calibrated) Unspecified when less than 15 °C above ambient
<b>Run time</b>	5 to 59 seconds
<b>CP1 Preheat time</b>	0 to 59 seconds
<b>Viscosity Resolution</b>	0.01 Poise
<b>Viscosity Accuracy</b>	± 2.0% (or better)
<b>Viscosity Repeatability</b>	± 0.5% (or better)
<b>Cone &amp; Plate</b>	Tungsten carbide
<b>Instrument Display</b>	128 x 64

### INTERFACE OUTPUTS:

<b>RS232</b>	9 way male D-type
--------------	-------------------

### POWER SUPPLY:

<b>Mains supply voltage range</b>	115Vac-230Vac
<b>CP1 Power consumption</b>	70W

### ENVIRONMENTAL:

<b>Storage temperature range</b>	-20°C to +50°C
<b>Specified operating temperature range</b>	+15°C to +35°C (plate 40°C to 220°C)
<b>Operating relative humidity conditions</b>	20% to 80% RH, non-condensing

**DIMENSIONS AND WEIGHT:**

**Dimensions** 350 x 300 555 mm (h x w x d)

**Weight:** 15kg approximately

**Fuse:** 2A (T) 230V Antisurge

**Standards:**

The instrument has been designed for use in accordance with National Standards Methods of Test BS3900: Part A7, ISO 2884-1 and ASTM D4287-00. It is highly recommended that the respective standard methods of test are obtained in order that samples are prepared and tested under the specified conditions, thus the results can be compared with similar sampling carried out by other operators on similar equipment.

The instrument has been designed to comply with current standards and safety legislation. The instrument complies with IEC61010-1 and conforms to the low voltage and EMC directives.

This instrument has been designed to meet the requirements of the EMC directive 2014/30/EU using the following standards:

EN61326:2013

Electrical equipment for measurement, control and laboratory use. EMC requirements

EN61000-4-3: 2002 A1

EN55011: 2009

EN55022(A)(B): 2010

61000-3-2: 2014

EN61010-1:2010 Safety requirements for electrical equipment for measurement, control and laboratory use

## 10 Operational accessories

---

Replacement cones (supplied without calibration oils)

Cone	Part number
0 - 5 Poise	490/754/D5
0 - 10 Poise	490/754/D1
0 - 20 Poise	490/754/D2
5 - 50 Poise	490/754/D3
10 - 100 Poise	490/754/D4

Calibration oils (25°C) – nominal values

Oil (Poise)	Part number
0.10	442/1
0.75	442/2
1.00	442/3
1.50	442/4
2.00	442/5
2.50	442/6
3.00	442/7
3.50	442/8
3.90	442/9
5.00	442/10
7.50	442/11
10.0	442/12
15.0	442/13

Oil (Poise)	Part number
25.0	442/14
39.0	442/15
60.0	442/16
77.5	442/17
100	442/18
150	442/19
200	442/20
0.14	442/21
0.28	442/22
3.90	442/23
20.0	442/24

This material is copyrighted by TQC Sheen and may not be reproduced in whole or in part by any means of information storage, retrieval, or reproduction without written permission from TQC Sheen

Copyright © 2018 TQC Sheen

**TQC SHEEN**

Molenbaan 19  
2908 LL Capelle a/d IJssel  
The Netherlands  
[www.tqcsheen.com](http://www.tqcsheen.com)